

アルカロイド
Alkaloids

J020828B

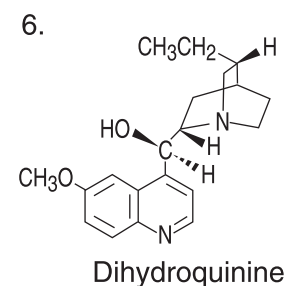
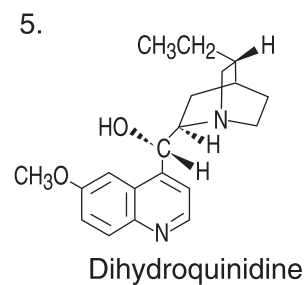
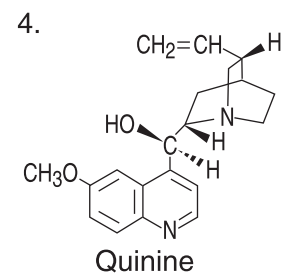
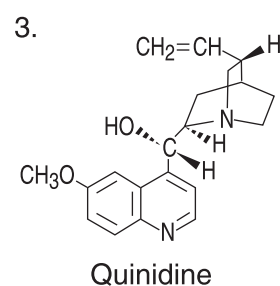
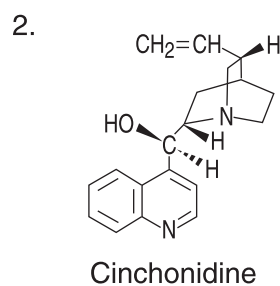
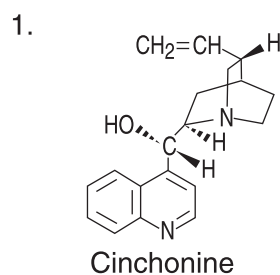
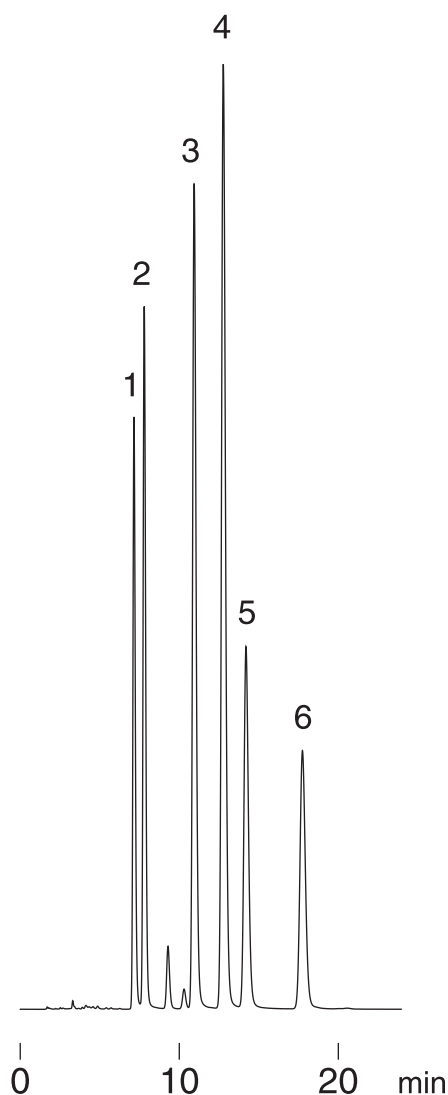

Column : Hydrosphere C18 (5 μ m, 12nm)
150 \times 4.6 mm I.D.
Eluent : methanol/20mM KH₂PO₄ (35/65)
Flow rate : 1.0 mL/min
Temperature : 37 $^{\circ}$ C
Detection : UV at 235 nm, 0.08 AUFS
Injection : 10 μ L (0.01~0.03 mg/mL)